

Instruction Manual

SYL-2342, SYL-2352 PID TEMPERATURE CONTROLLER INSTRUCTION MANUAL

Version 4.6

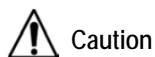

Caution

- This controller is intended to control equipment under normal operating conditions. If failure or malfunction of the controller may lead to abnormal operating conditions that may result in personal injury or damage to the equipment or other property, devices (limit or safety controls) or systems (alarm or supervisory) intended to warn of or protect against failure or malfunction of the controller must be incorporated into and maintained as part of the control system.
- Installing the rubber gasket supplied will protect the controller front panel from dust and water splash (IP54 rating). Additional protection is needed for higher IP rating.
- This controller carries a 90-day warranty. This warranty is limited to the controller only.

1. Specification

Input type	Thermocouple(TC): K, E, S, N, J, T, B, WRe5/26 RTD(Resistance temperature detector): Pt100, Cu50 DC Voltage: 0~5V, 1~5V, 0~1V, -100~100mV, -20~20mV, -5~5V, 0.2~1V. DC current : 0~10mA, 1~20mA, 4~20mA. (use external shunt resistor for higher current)
Input range	Please see section 4.7 for detail.
Accuracy	±0.2% Full scale: RTD, linear voltage, linear current and thermocouple input with ice point compensation or Cu50 copper compensation. 0.2% Full scale or ±2 °C: thermocouple input with internal automatic compensation. Note: for thermocouple B, the measurement accuracy of ± 0.2% can only be guaranteed when input range is between 600~1800 °C.
Response time	≤ 0.5s (when FIL=0)
Display resolution	1 °C, 1 °F; or 0.1 °C
Control mode	Fuzzy logic enhanced PID control On-off control Manual control
Output mode	Relay contact (NO): 250VAC/7A, 120V/10A, 24VDC/10A SSR voltage output: 12VDC/30mA
Alarm output	Relay contact: 250VAC/1A, 120VAC/3A, 24V/3A
Alarm function	Process high alarm, process low alarm, deviation high alarm, and deviation low alarm
Manual function	Automatic/Manual bumpless transfer
Power supply	85~260VAC/50~60Hz
Power consumption	≤5 Watt
Ambient temperature	0~50°C, 32~122°F
Dimension	48 x 48 x 100 mm (WxHxD)
Mounting cutout	45 x 45 mm

2. Available Configurations

Table 1. Controller models

Model	Control output	Ramp/soak option
SYL-2342	Relay contact output	No
SYL-2352	SSR control output	No
SYL-2342P	Relay contact output	Yes
SYL-2352P	SSR control output	Yes

All the models listed in table 1 are 1/16 DIN size with dual-alarm outputs.

3. Terminal Wiring

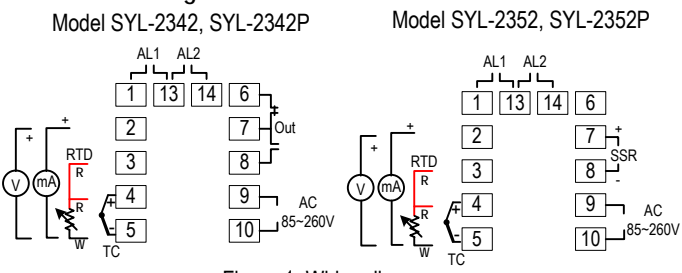

Figure 1. Wiring diagram

3.1 Sensor connection

Please refer to table 3 for the input sensor type (Sn) setting codes. The initial setting for input is for a K type thermocouple. Set Sn to the right sensor code if another sensor type is used.

3.1.1 Thermocouple

The thermocouple should be connected to terminals 4 and 5. Make sure that the polarity is correct. There are two commonly used color codes for the K type thermocouple. US color code uses yellow (positive) and red (negative). Imported DIN color code uses red (positive) and green/blue (negative). The temperature reading will decrease as temperature increases if the connection is reversed.

When using ungrounded thermocouple that is in touch with a large conductive subject, the electromagnetic field picked up by the sensor tip might be too large for the controller to handle, the temperature display will change erratically. In that case, connecting the shield of thermocouple to terminal 5 (circuit ground of the controller) might solve the problem. Another option is to connect the conductive subject to terminal 5.

3.1.2 RTD sensor

For a three-wire RTD with standard DIN color code, the two red wires should be connected to the terminals 3 and 4. The white wire should be connected to terminal 5. For a two-wire RTD, the wires should be connected to terminals 4 and 5. Jump a wire between terminals 3 and 4. Set controller input type, Sn to 21.

3.1.3 Linear input (V, mV, mA or resistance)

V and mA current signal inputs should be connected between terminals 2 and 5. Terminal 2 is positive.

mV signal inputs should be connected between terminals 4 and 5. Terminal 4 is positive. For resistance inputs, short terminals 3 and 4, then connect resistance inputs between terminals 4 and 5.

3.2 Power to the controller

The power cables should be connected to terminals 9 and 10. Polarity does not matter. It can be powered by 85-260V AC power source. Neither a transformer nor jumper is needed to wire it up. For the sake of consistency with the wiring example described later, we suggest you connect the hot wire to terminal 9 and neutral to 10.

3.3 Control output connection

The SSR control output of the controller SYL-2352 provides a 12V DC signal that can control up to 5 SSRs in parallel. The relay output of the controller SYL-2342 can be used to turn on a contactor or a solenoid valve. It can drive a small heater directly if the heater draws less than 10 Ampere when connected to 120V AC power source. For applications needing two control outputs, such as one for heating and another for cooling, relays AL1 or AL2 can be used for the second output with on/off control mode. Please see Figure 11 for details.

3.3.1 Connecting the load through SSR (for SYL-2352)

Connect terminal 7 to the positive input and terminal 8 to the negative input of the SSR. See Figure 8 and 9 for details.

3.3.2 Connecting the load through a contactor (for SYL-2342)

Assuming the controller is powered by 120V AC and the contactor has a 120V AC coil, jump a wire between terminals 8 and 9. Connect terminal 7 to one lead of the coil and terminal 10 to the other lead of the coil. Please see Figure 7 for example.

3.3.3. Connecting the heater (or cooler) directly from the internal relay

Assuming the controller and the load (heater or cooler) are powered by the same voltage. Jump a wire from terminal 9 to 8. Connect terminal 7 to the one lead of the load and terminal 10 to the other lead of the load. Please see Figure 6 and 11 for details.

3.4 For first time users without prior experience with PID controllers, the following notes may prevent you from making common mistakes.

3.4.1 Power to the heater does not flow through terminal 9 and 10 of the controller. The controller consumes less than 2 watts of power. It only provides a control signal to the relay. Therefore, wires in the 18 to 26 gauge range should be used for providing power to terminals 9 and 10. Thicker wires may be more difficult to install.

3.4.2 The control relay outputs (for SYL-2342), -AL1 and AL2, are "dry" single pole switches. They do not provide power by themselves. Please see Figure 6, 7 and 11 for how they are wired when providing a 120V output (or when output voltage is the same as the power source for the controller). If the load of the relay requires a different voltage than that for the controller, another power source will be needed. See Figure 10 for examples.

3.4.3 SSR output power does not come from the input of the SSR. The output of the SSR is a single pole switch between terminals 1 and 2 of the SSR. The input of the SSR is for control, or triggering the SSR. (Please note we are talking about the SSR itself, not the SSR control output of the controller). When switching a North American 240V AC power, the heater will be live even when the SSR is off. Users should install a double pole mechanical switch to the power input.

3.4.4. For all controller models listed in this manual, the power is controlled by regulating the duration of on time for a fixed period of time. It is not controlled by regulating amplitude of the voltage or current. This is often referred as time proportional control. e.g. If the cycle rate is set for 100 seconds, a 60% output means controller will switch on the power for 60 seconds and off for 40 seconds (60/100=60%). Almost all high power control systems use time proportional control because amplitude proportional control is too expensive and inefficient.

4. Front Panel and Operation

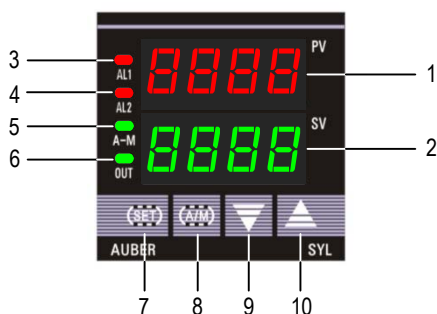

Figure 2. Front panel

- ① PV display: Indicates the sensor read out, or process value (PV).
- ② SV display: Indicates the set value (SV) or output value (%).
- ③ AL1 indicator: It lights up when AL1 relay is on.
- ④ AL2 indicator: It lights up when AL2 relay is on.
- ⑤ A-M indicator: The light indicates that the controller is in manual mode. For the controllers with the Ramp/Soak option, this light indicates that the program is running.
- ⑥ Output indicator: It is synchronized with control output (terminal 7 and 8), and the power to the load. When it is on, the heater (or cooler) is powered.
- ⑦ SET key: When it is pressed momentarily, the controller will switch the lower (SV) display between set value and percentage of output. When pressed and held for two seconds will put the controller into parameter setting mode.
- ⑧ Automatic/Manual function key (A/M) /Data shift key
- ⑨ Decrement key ▼: Decreases numeric value of the setting value.
- ⑩ Increment key ▲: Increases numeric value of the setting value.

4.1 Display Status

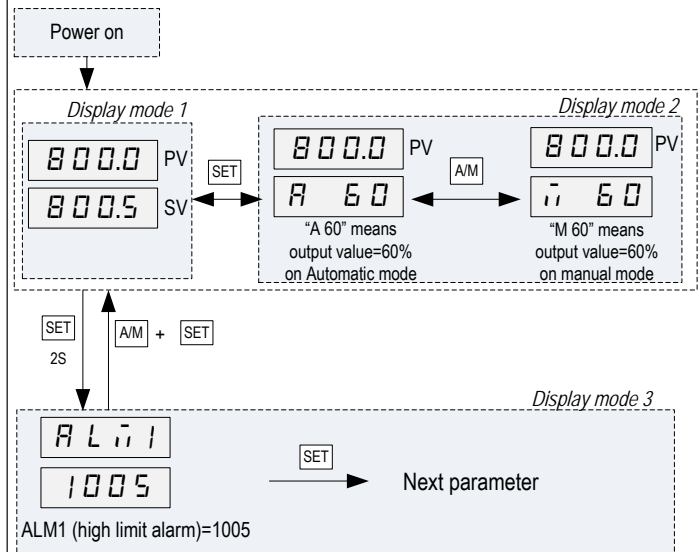

Figure 3. Display modes

Display mode 1: When the power is turned on, the upper display window shows the measured value (PV) and the lower window shows the four-digit set value (SV).

Display mode 2: Press the SET key to change the display status into mode 2. The upper display window shows the measured value (PV) and the lower windows shows the output value. This picture shows the output percentage is 60% when in Automatic (PID) control mode. If parameter A-M=1 (see table 2), pressing the A/M key will switch the controller between PID and Manual control mode with the output unchanged. -This bumpless transfer allows the controller to be switched between manual and automatic mode without the output suddenly 'bumping' to a different value.

Display mode 3: Press the SET key for 2 seconds to enter the display mode 3. This mode allows users to change the system parameters.

4.2 Basic Operation

4.2.1 Changing set value (SV)

Press the ▼ or ▲ key once, and then release it. The decimal point on the lower right corner will start to flash. Press the ▼ or ▲ key to change SV until the desired value is displayed. If the change of SV is large, press the A/M key to move the flashing decimal point to the desired digit that needs to be changed. Then press the ▼ or ▲ key to start changing SV from that digit. The decimal point will stop flashing after no key is pressed for 3 seconds. The changed SV will be automatically registered without pressing the SET key.

4.2.2 Display change

Press the SET key to change the display mode. The display can be changed between display modes 1 and 2.

4.2.3 Manual/Automatic mode switch

Bumpless switching between PID mode and Manual mode can be performed by pressing the A/M key. The A-M LED will light up when the controller is in Manual mode. In Manual mode, the output amplitude can be increased or decreased by pressing ▲ and ▼ (display mode 2).

Please note that manual control is initially disabled (A/M=2). To activate the manual control, set A/M=0 or 1.

4.2.4 Parameter Setup Mode

When the display mode is 1 or 2, press SET and hold for roughly 2 seconds until the parameter setup menu is displayed (display mode 3). Please refer to 4.3 for how to set the parameters.

4.3 Setup flow chart

While in the parameter setup mode, use ▲ and ▼ to modify a digit and use A/M to select the digit that needs to be modified. Press the A/M and SET key at the same time to exit the parameter setup mode. The instrument will automatically exit if no key is pressed for 10 seconds. Figure 4 is the setup flow chart.

Please note the changed parameter will be automatically registered without pressing the SET key. If the controller is locked (see 4.17), only limited parameters (or no parameters) can be changed.

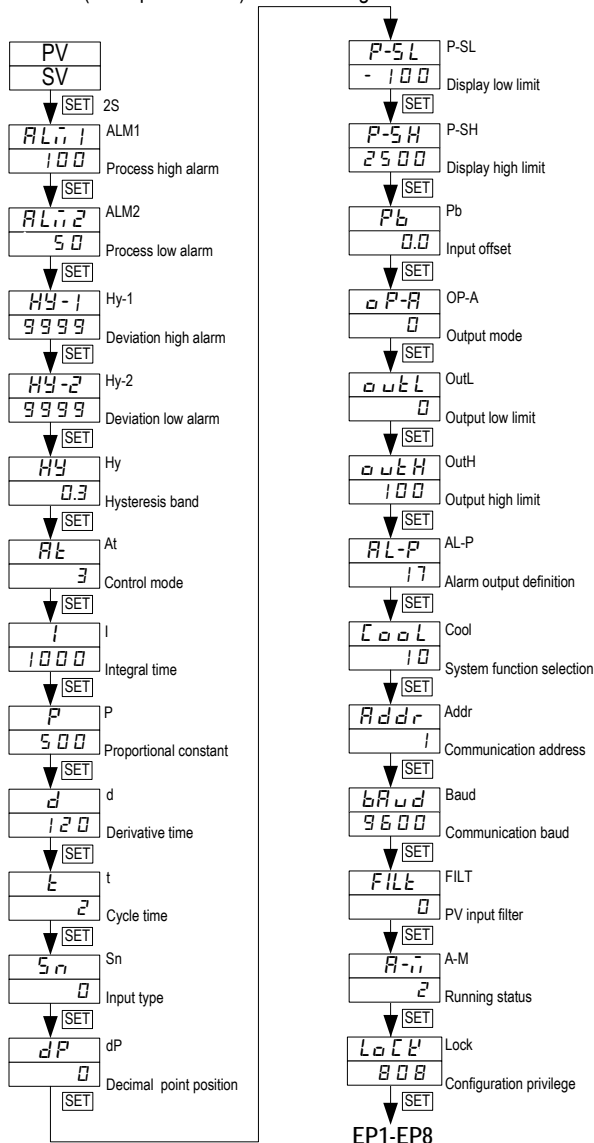

Figure 4. System setup flow chart

4.4 Parameter Setting

Table 2. System parameters

Code	Description	Setting Range	Initial Setting	Remarks
ALM1	Process high alarm	-1999~+9999 °C or °F	100	See 4.4.1
ALM2	Process low alarm	-1999~+9999 °C or °F	50	
Hy-1	Deviation high alarm	0~9999 °C or °F	9999	
Hy-2	Deviation low alarm	0~9999 °C or °F	9999	
Hy	Hysteresis Band	0~200.0 °C or °F or 0~2000 for linear input	0.3	See 4.4.2
At	Auto tuning	0~3. Set to 1 or 2 to start auto tuning	3	See 4.4.3
I	Integral time	0~9999	1000	See 4.5.1
P	Proportional Constant	1~9999 %	500	
d	Derivative Time	0~2000	120	
t	Cycle time	2~125	2 for SSR 20 for relay	See 4.6
Sn	Input type	0~37	0 (K type TC)	See 4.7
dP	Decimal point position	0~3	0	See 4.8
P-SL	Display low limit	-1999~+9999 °C or °F	-100	See 4.9
P-SH	Display high limit	-1999~+9999 °C or °F	2500	
Pb	Input offset	-1999~+4000 -1999~+9999 °C or °F	0.0	See 4.10
OP-A	Output mode	0~2	0	See 4.11
OUTL	Output low limit	0~110 %	0	See 4.12
OUTH	Output high limit	0~110 %	100	
AL-P	Alarm output definition	0~31	17	See 4.13
COOL	System function selection	0~15	10	For heating and °F display, see 4.14
Addr	Communication address	0~20	1	Ignore this setting
bAud	Communication baud rate	0~19200	9600	Ignore this setting
FILT	PV input filter	0~20	0	See 4.15
A-M	Automatic/Manual status	0. Manual 1. Automatic 2. Manual suppressing	2	Manual control is disabled. Set to 1 to activate. See 4.16
Lock	Configuration privilege	0~9999	808	All parameters are unlocked. See 4.17
EP1-EP8	Field parameter definition	nonE ~ A-M	nonE	To be defined by user. See 4.17

4.4.1 Alarm parameters

This controller offers four types of alarm, "ALM1", "ALM2", "Hy-1", "Hy-2".

- ALM1: High limit absolute alarm. If the process value is greater than the value specified as "ALM1+Hy" (Hy is the Hysteresis Band), then the alarm will turn on. It will turn off when the process value is less than "ALM1-Hy".
- ALM2: Low limit absolute alarm. If the process value is less than the value specified as "ALM2-Hy", then the alarm will turn on, and the alarm will turn off if the process value is greater than "ALM2+Hy".
- Hy-1: Deviation high alarm. If the temperature is above "SV+Hy-1 +Hy", the alarm will turn on, and the alarm will turn off if the process value is less than "SV+Hy-1 -Hy" (we will discuss the role of Hy in the next section)
- Hy-2: Deviation low alarm. If the temperature is below "SV-Hy-2 -Hy", the alarm will turn on, and the alarm will turn off if the temperature is greater than "SV-Hy-2 +Hy".

The things you should know about alarm

1) Absolute alarm and deviation alarm

High (or low) limit absolute alarm is set by the specific temperatures that the alarm will be on. Deviation high (or low) alarm is set by how many degrees above (or below) the control target temperature (SV) that the alarm will be on. e.g. Assuming ALM1=1000 °F, Hy-1=5 °F, SV=700 °F. When the probe temperature (PV) is above 705, the deviation alarm will be on. When the temperature is above 1000 °F, the process high alarm will be on. Later, when SV changes to 600 °F, the deviation alarm will be changed to 605 but process high alarm will remain the same. Here the Hysteresis Band (Hy) setting is ignored. Please see 4.5.2 for details.

2) Alarm Suppression feature

Sometimes, user may not want the low alarm to be turned on when starting the controller at a temperature below the low alarm setting. The Alarm Suppression feature will suppress the alarm from turning on when the controller is powered up (or SV changes). The alarms can only be activated after the PV has reached SV.

This feature is controlled by the B constant of the COOL parameter (see 4.14). The default setting is alarm suppression on. If you use the AL1 or AL2 relay for a control application that needs it to be active as soon as the controller is powered up, you need to turn off the alarm suppression by setting B=0.

3) Assignment of the relays for the alarms

AL1 and AL2 are the name of the two relays used for alarm output. AL1 is the alarm relay 1 and AL2 is alarm relay 2. Please do not confuse the relays with alarm parameter ALM1 (process high alarm) and ALM2 (process low alarm). Either the AL1 or the AL2 can be used for any of the four alarms. AL-P (alarm output definition) is a parameter that allows you to select the relay(s) to be activated when the alarm set condition is met.

You can set all four alarms to activate the one relay (AL1 or AL2), but you can't activate both relays for with just one alarm.

4) Display of the alarm

When AL1 or AL2 relay is activated, the LED on the upper left will light up. If you have multiple alarms assigned to a single relay, you might want to know which alarm activated the relay. This can be done by setting the E constant in the AL-P parameter (see 4.13). When E=0, the bottom display of the controller will alternately display the SV and the activated alarm parameter.

5) Activate the AL1 and AL2 by time instead of temperature

For the controllers with the ramp and soak function (SYL-2342P and SYL-2352P), AL1 and AL2 can be activated when the process reaches a specific time. This is discussed in the section 3.7 of "Supplementary Instruction Manual for ramp/soak option.

4.4.2 Hysteresis Band "Hy"

The Hysteresis Band parameter Hy is also referred as Dead Band, or Differential. It permits protection of the on/off control from high switching frequency caused by process input fluctuation. Hysteresis Band parameter is used for on/off control, 4-alarm control as well as the on/off control at auto tuning. For example: 1) When controller is set for on/off heating control mode, the output will turn off when temperature goes above SV+Hy and on again when it drops to below SV-Hy. 2) If the high alarm is set at 800 °F and hysteresis is set for 2 °F, the high alarm will be on at 802 °F (ALM1+Hy) and off at 798 °F (ALM1-Hy).

Please note that the cycle time can also affect the action. If the temperature passes the Hy set point right after the start of a cycle, the controller will not respond to the Hy set point until the next cycle. If cycle time is set to 20 seconds, the action can be delay as long as 20 seconds. Users can reduce the cycle time to avoid the delay.

4.4.3 Control mode "At"

At=0 On/off control. It works like a mechanical thermostat. It is suitable for devices that do not like to be switched at high frequency, such as motor and valves. See 4.5.2 for details.

At=1 Gets the controller ready to start the Auto tuning process by pressing the A/M key.

At=2 Start auto tuning. The function is the same as starting auto tuning from front panel.

At=3 This configuration is automatically set after auto tuning is done. Auto

tuning from the front panel is inhibited to prevent accidental re-starting of the auto tuning process. To start auto tuning again, set At=1 or At=2.

4.5 Control action explanations

4.5.1 PID

Please note that because this controller uses fuzzy logic enhanced PID control software, the definition of the control constants (P, I and d) are different than that of the traditional proportional, integral, and derivative parameters.

In most cases the fuzzy logic enhanced PID control is very adaptive and may work well without changing the initial PID parameters. If not, users may need to use auto-tune function to let the controller determine the parameters automatically. If the auto tuning results are not satisfactory, you can manually fine-tune the PID constants for improved performance. Or you can try to modify the initial PID values and perform auto tune again. Sometimes the controller will get the better parameters.

The auto-tune can be started in two ways. 1) Set At=2. It will start automatically after 10 seconds. 2) Set At=1. Then you can start the auto-tune any time during the normal operation by pressing the A/M key. During auto tuning, the instrument executes on-off control. After 2-3 times on-off action, the microprocessor in the instrument will analyze the period, amplitude, waveform of the oscillation generated by the on-off control, and calculate the optimal control parameter value. The instrument begins to perform accurate artificial intelligence control after auto tuning is finished. If you want to exit from auto tuning mode, press and hold the (A/M) key for about 2 seconds until the blinking of "At" symbol is stopped in the lower display window. Generally, you will only need perform auto tuning once. After the auto tuning is finished. The instrument will set parameter "At" to 3, which will prevent the (A/M) key from triggering auto-tune. This will prevent an accidental repeat of the auto-tuning process.

(1) Proportional constant "P"

Please note the P constant is not defined as Proportional Band as in the traditional model. Its unit is not in degrees. A larger constant results in larger and quicker action, which is the opposite of the traditional proportional band value. It also functions in the entire control range rather than a limited band.

If you are controlling a very fast response system (>1 °F/second) that fuzzy logic is not quick enough to adjust, set P=1 will change the controller to the traditional PID system with a moderate gain for the P.

(2) Integral time "I"

Integral action is used to eliminate offset. Larger values lead to slower action. Increase the integral time when temperature fluctuates regularly (system oscillating). Decrease it if the controller is taking too long to eliminate the temperature offset. When I =0, the system becomes a PD controller.

(3) Derivative time "D"

Derivative action can be used to minimize the temperature over-shoot by responding to its rate of change. The larger the number, the faster the action.

4.5.2 On/off control mode

It is necessary for inductive loads such as motors, compressors, or solenoid valves that do not like to take pulsed power. It works like a mechanical thermostat. When the temperature passes the set point, the heater (or cooler) will be turned off. When the temperature drops back to below the hysteresis band (Hy) the heater will turn on again.

To use the On/off mode, set At=0. Then, set the Hy to the desired range based on control precision requirements. Smaller Hy values result in tighter temperature control, but also cause the on/off action to occur more frequently.

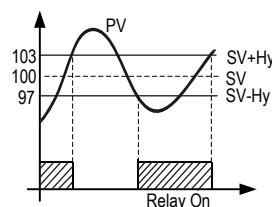

When heating, At=0
If $PV \leq (SV - Hy)$, relay on
If $PV \geq (SV + Hy)$, relay off
(SV=100, Hy=3)

Figure 5. On/off control mode

4.5.3. Manual mode

Manual mode allows the user to control the output as a percentage of the total heater power. It is like a dial on a stove. The output is independent of the temperature sensor reading. One application example is controlling the strength of boiling during beer brewing. You can use the manual mode to control the boiling so that it will not boil over to make a mess. The manual mode can be switched from PID mode but not from On/off mode. This controller offers a “bumpless” switch from the PID to manual mode. If the controller outputs 75% of power at PID mode, the controller will stay at 75% when it is switched to the manual mode, until it is adjusted manually. See Figure 3 for how to switch the display mode. The Manual control is initially disabled (A/M=2). To activate the manual control, set A/M=0 or 1.

4.6 Cycle time “t”

It is the time period (in seconds) that the controller uses to calculate its output. e.g. When t=2, if the controller decides output should be 10%, the heater will be on 0.2 second and off 1.8 seconds for every 2 seconds. Smaller t values result in more precision control. For SSR output, t is set at the minimum (2 seconds). For relay or contactor output, it should be set longer to prevent contacts from wearing out too soon. Normally it is set to 20~40 seconds.

4.7 Input selection code for “Sn”

Table 3. Code for Sn and its range.

Sn code	Input device	Display range (°C)	Display range (°F)
0	K (thermocouple)	-50~+1300	-58~2372
1	S(thermocouple)	-50~+1700	-58~3092
2	WRe (5/26) (thermocouple)	0~2300	32~4172
3	T (thermocouple)	-200~350	-328~662
4	E (thermocouple)	0~800	32~1472
5	J (thermocouple)	0~1000	32~1832
6	B (thermocouple)	0~1800	32~3272
7	N (thermocouple)	0~1300	32~2372
20	Cu50 (RTD)	-50~+150	-58~302
21	Pt100 (RTD)	-200~+600	-328~1112
26	0~80Ω	-1999~+9999 Defined by user with P-SL and P-SH	
27	0~400Ω		
28	0~20mV		
29	0~100 mV		
30	0~60 mV		
31	0~1V		
32	0.2~1V 4~20mA (w/ 50Ω Resistor)		
33	1~5V 4~20mA (w/ 250Ω Resistor)		
34	0~5V		
35	-20~+20mV		
36	-100~+100mV		
37	-5V~+5V		

4.8 Decimal point setting “dP”

1) In case of thermocouple or RTD input, dP is used to define temperature display resolution.

dP=0, temperature display resolution is 1 °C (°F).

dP=1, temperature display resolution is 0.1 °C . The 0.1 degree resolution is only available for Celsius display. The temperature will be displayed at the resolution of 0.1 °C for input below 1000 °C and 1 °C for input over 1000 °C.

2) For linear input devices (voltage, current or resistance input, Sn=26-37)

Table 4. dP parameter setting

dP Value	0	1	2	3
Display format	0000	000.0	00.00	0.000

4.9 Limiting the control range, “P-SH” and “P-SL”

1) For temperature sensor input, the “P-SH” and “P-SL” values define the set value range. P-SL is the low limit, and P-SH is the high limit.

e.g. Sometimes, you may want to limit the temperature setting range so that the operator can't set a very high temperature by accident. If you set the P-SL=100 and P-SH =130, operator will only be able to set the temperature between 100 and 130.

2) For linear input devices, “P-SH” and “P-SL” are used to define the display span. e.g. If the input is 0-5V. P-SL is the value to be displayed at 0V and P-SH is the value at 5V.

4.10 Input offset “Pb”

Pb is used to set an input offset to compensate the error produced by the sensor or input signal itself.

For example, if the controller displays 5 °C when probe is in ice/water mixture, setting Pb=-5, will make the controller display 0 °C.

4.11 Output definition “OP-A”

This parameter is not used for this model. It should not be changed.

4.12 Output range limits “OUTL” and “OUTH”

OUTL and OUTH allow you set the output range low and high limit. OUTL is a useful feature for a system that needs to have a minimum amount of power as long as the controller is powered. e.g. If OUTL=20, the controller will maintain a minimum of 20% power output even when input sensor failed. OUTH can be used when you have an overpowered heater to control a small subject. e.g. If you set the OUTH=50, the 5000 watt heater will be used as 2500W heater (50%) even when the PID wants to send 100% output.

4.13 Alarm output definition “AL-P”

Parameter “AL-P” may be configured in the range of 0 to 31. It is used to define which alarms (“ALM1”, “ALM2”, “Hy-1” and “Hy-2”) is output to AL1 or AL2. Its function is determined by the following formula:

$$AL-P=AX1+BX2+CX4+DX8+EX16$$

If A=0, then AL2 is activated when Process high alarm occurs;

If A=1, then AL1 is activated when Process high alarm occurs;

If B=0, then AL2 is activated when Process low alarm occurs;

If B=1, then AL1 is activated when Process low alarm occurs;

If C=0, then AL2 is activated when Deviation high alarm occurs;

If C=1, then AL1 is activated when Deviation high alarm occurs;

If D=0, then AL2 is activated when Deviation low alarm occurs;

If D=1, then AL1 is activated when Deviation low alarm occurs;

If E=0, then alarm types, such as “ALM1” and “ALM2” will be displayed alternatively in the lower display window when the alarms are on. This makes it easier to determine which alarms are on.

If E=1, the alarm will not be displayed in the lower display window (except for “orAL”). Generally this setting is used when the alarm output is used for control purposes.

For example, in order to activate AL1 when a Process high alarm occurs, trigger AL2 by a Process low alarm, Deviation high alarm, or Deviation low alarm, and not show the alarm type in the lower display window, set A=1, B=0, C=0, D=0, and E=1. Parameter “AL-P” should be configured to:

$$AL-P=1X1+0X2+0X4+0X8+1X16=17 \text{ (this is the factory default setting)}$$

Note: Unlike controllers that can be set to only one alarm type (either absolute or deviation but not both at same time), this controller allows both alarm types to function simultaneously. If you only want one alarm type to function, set the other alarm type parameters to maximum or minimum (ALM1, Hy-1 and Hy-2 to 9999, ALM2 to -1999) to stop its function.

4.14 “COOL” for Celsius, Fahrenheit, Heating, and Cooling Selection

Parameter “COOL” is used to set the display unit, heating or cooling, and alarm suppression. Its value is determined by the following formula:

$$COOL=AX1+BX2+CX8$$

A=0, reverse action control mode for heating control.

A=1, direct action control mode for cooling control.
 B=0, without alarm suppressing when turned on or when set point changes.
 B=1, alarm suppressing at power up or set point changes.
 C=0, display unit in °C.
 C=1, display unit in °F.
 The factory setting is A=0, B=1, C=1 (heating, with alarm suppression, display in Fahrenheit). Therefore,
 COOL=0X1+1X2+1X8=10
 To change from Fahrenheit to Celsius display, set COOL=2

4.15 Input digital filter "FILt"

If measurement input fluctuates due to noise, then a digital filter can be used to smooth the input. "FILt" may be configured in the range of 0 to 20. Stronger filtering increases the stability of the readout display, but causes more delay in the response to change in temperature. FILt=0 disables the filter.

4.16 Manual and Automatic Mode Selection "A-M"

Parameter A-M is for selecting automatic or manual control mode.

A-M=0, manual control mode

A-M=1, automatic control mode (either PID or On/off control)

A-M=2, automatic control mode, in this state manual operation is prohibited

This parameter functions differently for controllers with the ramp/soak function (see supplemental manual for details).

4.17 Lock up the settings, field parameter "EP" and parameter "Lock"

To prevent the operator from changing the settings by accident, you can lock the parameter settings after initial setup. You can select which parameter can be viewed or changed by assigning one of the field parameters to it. Up to 8 parameters can be assigned into field parameter EP1-EP8. The field parameter can be set to any parameter listed in Table 2, except parameter EP itself. When Lock is set to 0, 1, 2, and so on, only parameters or setting values of program defined in an EP can be displayed. This function can speed up parameter modification and prevent critical parameters (like input, output parameters) from being modified.

If the number of field parameters is less than 8, then define the first unused parameter as none. For example, if only ALM1 and ALM2 need to be modified by field operators, the parameter EP can be set as following:

Lock=0, EP1=ALM1, EP2=ALM2, EP3=nonE.

In this case, the controller will ignore the field parameters from EP4 to EP8. If field parameters are not needed after the instrument is initially adjusted, simply set EP1 to nonE.

Lock code 0, 1 and 2 will give the operator limited privileges to change some of the parameters that can be viewed. Table 5 shows the privileges associated with each lock code.

Table 5. LockK parameter

LockK value	SV Adjustment	EP1-8 Adjustment	Other parameters
0	Yes	Yes	Locked
1	Yes	No	Locked
2	No	Yes	Locked
3 and up	No	No	Locked
808			unlocked

Note: to limit the control temperature range instead of completely locking it, please refer to section 4.9.

5. Wiring examples

5.1 Controlling the load directly with internal relay

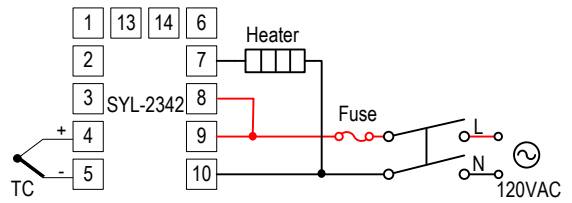

Figure 6. SYL-2342 or SYL-2342P control the heater directly by the internal relay of the controller. The heater must consume less current than the internal relay's maximum rating (7A at 240VAC and 10A at 120VAC).

5.2 Controlling the load via external contactor

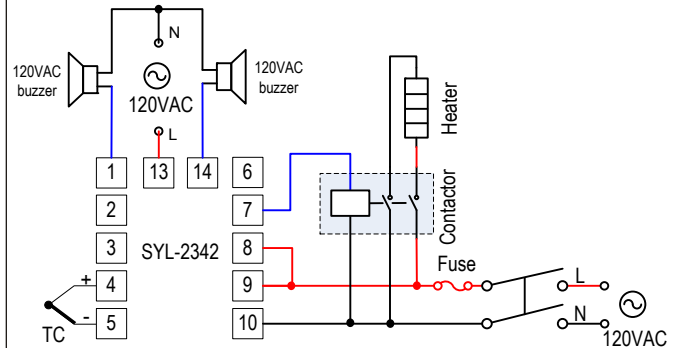

Figure 7. SYL-2342 or SYL-2342P with thermocouple input and external relay output. This is a typical wiring for oven and kiln.

Using the external contactor allows users to control higher power loads than the internal relay can handle. It is also easy to service. If the contacts of the relay wear out, it is more economical to replace them than to repair the controller. In this example, we assume the coil voltage of the contactor is the same as the voltage of the controller power supply. The voltage of power supply for alarm is 120V AC. Note: You don't have to wire or set the alarm to control the temperature. It is just to show how the alarm can be wired.

5.3 Controlling the load via SSR

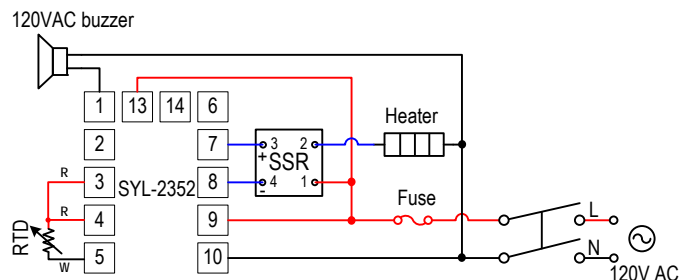

Figure 8. SYL-2352 or SYL-2352P with RTD input. This is a typical wiring for controlling the temperature of a tank of liquid with high precision.

The RTD sensor can offer accuracy within a fraction of a degree. The SSR allows the heater to be switched at higher frequency for better stability. It also has longer life time than the electromechanical relay. A proper heat sink is needed when the SSR switches >8A of current. For wiring a 240V heater, please see 5.4.

5.4 Controlling the load via SSR, 240VAC example

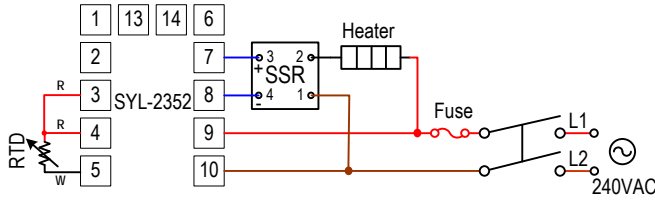

Figure 9. This is the essentially the same wiring example as 5.3, except the heater and controller are powered by 240V AC. An alarm is not installed in this example.

5.5 Controlling a 24V valve

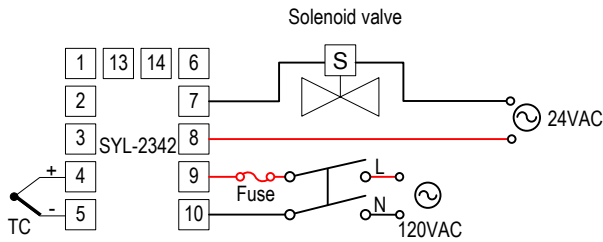

Figure 10. SYL-2342 or SYL-2342P with thermocouple input. This is a typical wiring set up for a 24V gas, hot water valve, or a contactor with 24V coil voltage.

5.6 Cooling and heating with the same controller

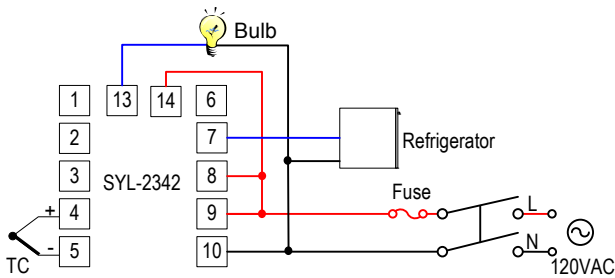

Figure 11. A refrigerator connected to SYL-2342 directly

This is an example for beer fermentation. The refrigerator is driven by the internal relay of the controller directly. Please note that the internal relay output (terminals 7 and 8) is not powered by itself. A power supply must be used to drive the external relay. The refrigerator must consume less current than the internal relay's maximum rating (7A at 240V AC and 10A at 120V AC). The bulb (less than 100-300 W) is for heating. The example is setup to have the heater to turn on when temperature drops to below 60 °F and turns off at 64 °F. The refrigerator will turn on when temperature is above 69 °F and turn off at 65 °F.

Set up for the controller

- 1) Hy = 2.0. Set both hysteresis band for heater and cooler to 2 degree.
- 2) COOL=9. Set the controller to cooling mode, no alarm suppression, Fahrenheit temperature unit display.
- 3) AT=0. Set the controller main output to on/off control mode for refrigerator compressor control
- 4) ALM2=62. Set the low limit alarm to 62 °F. Heater will be on at 60 °F (ALM2-Hy) and off at 64 °F (ALM2+Hy)
- 5) SV=67. Refrigerator will be on at 69 °F (SV+Hy) and off at 65 °F (SV-Hy).

Quick Guide for SYL-2342, 2352

1. Wiring

1) Power to the controller. Connect the 85-260V AC power to terminals 9 and 10.

2) Control output connection. Connect terminals 7 and 8 for output.

3) Sensor connection. For thermocouples, connect the positive wire to terminal 4, the negative to terminal 5. For a three-wire RTD with standard DIN color code, connect the two red wires to terminals 3 and 4, and connect the white wire to terminal 5. For a two-wire RTD, connect the wires to terminals 4 and 5. Then, jump a wire between terminals 3 and 4.

2. Set sensor type

Set Sn to 0 for a K type thermocouple (default), 5 for a J type thermocouple, and 21 for a Pt100 RTD.

3. Switching between automatic and manual mode

Set A-M=1 to active manual mode. Press the A/M key to switch between automatic and manual mode.

4. Changing the temperature scale from Fahrenheit to Celsius.

Change COOL from 10 to 2 (for heating mode).

5 Setting the controller for cooling control.

For cooling control, set COOL=11 to display Fahrenheit; set COOL=3 to display Celsius.

6. Setting target temperature (SV)

Press the ▼ or ▲ key once, and then release it. The decimal point on the lower right corner will start to flash. Press the ▼ or ▲ key to change SV until the desired value is displayed. The decimal point will stop flashing after no key is pressed for 3 seconds. You can press the A/M key to move the flashing decimal point to the desired digit that needs to change. Then press the ▼ or ▲ key to change SV starting from that digit.

7. Auto-tune

You can use the auto-tune function to determine the PID constants automatically.

There are two ways to start auto-tuning:

1) Set At=2. It will start automatically after 10 seconds.

2) Set At=1. Then during the normal operation, press the A/M key to start the auto-tune.

The instrument will perform accurate artificial intelligence control after auto tuning is finished.

7 On/off mode

Set At=0 to active the on/off control mode.

Set the Hysteresis Band parameter Hy to be a desired value.

8. Error Message and trouble shooting

8.1 Display orAL

This is an input error message. The possible reasons are: the sensor is not connected correctly; the input setting is wrong type; or the sensor is defective. In this case, the instrument terminates its control function automatically, and the output value is fixed according to the parameter OUTL. If this happens when using thermocouple sensor, you can short terminal 4 and 5 with a copper wire. If the display shows ambient temperature, the thermocouple is defective. If it still displays orAL, check the input setting, Sn, to make sure it is set to the right thermocouple type. If the Sn setting is correct, the controller is defective. For RTD sensors, check the input setting first because most controllers are shipped with the input set for thermocouples. Then check the wiring. The two red wires should be connected to terminals 3 and 4. The clear wire should be connected to terminal 5.

8.2 No heating

When the controller output is set for relay output, the "O U T" LED is synchronized with output relay. If heat is not output when it is supposed to, check the OUT LED first. If it is not lit, the controller parameter settings are wrong. If it is on, check the external switching device (if the relay is pulled-in, or the SSR's red LED is on). If the external switching device is on, then the problem is either the external switching device output, its wiring, or the heater.

If the external switching device is not on, then the problem is either the controller output, or the external switch device.

8.3 Poor Accuracy

Please make sure calibration is done by immersing the probe in liquid. Comparing the reference in air is not recommended because response time of the sensor depends on its mass. Some of our sensors have response time >10 minutes in the air. When the error is larger than 5 °F, the most common problem is an improper connection between the thermocouple and the controller. The thermocouple needs to be connected directly to the controller unless a thermocouple connector and extension wire is used. Copper wire or a thermocouple extension wire with the wrong polarity connected on the thermocouple will cause the reading to drift more than 5 °F.

8.4 On on/off mode, although hysteresis is set to 0.3, the unit is running 5 degrees above and below.

If the Hy is very small and temperature changes very quickly, users will need to consider the delay of the cycle time (the parameter t). For example, if cycle time is 20 seconds, when the temperature passes the SV+Hy after the beginning of a 20 seconds cycle, the relay will not act until the start of the next cycle 20 seconds later. Users may change the cycle time to a smaller value, such as 2 seconds, to get better precision control.

Auber Instruments Inc.

5755 North Point Parkway, Suite 99,
Alpharetta, GA 30022

www.auberins.com

e-mail: info@auberins.com Tel: 770-569-8420